

Hogwarts
Great Hall & Astronomy Tower

3D
Puzzle

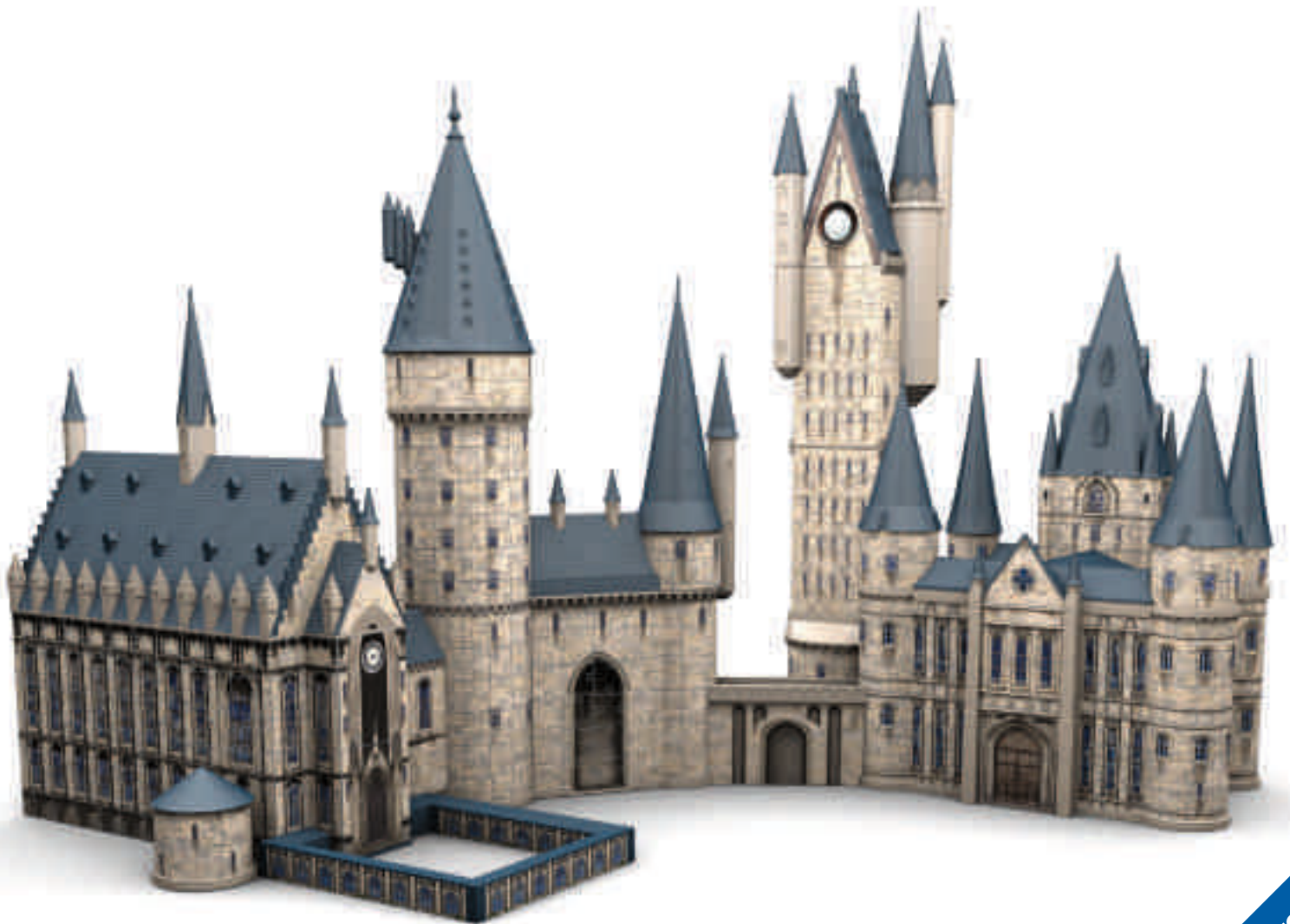



499-524

283-306



1-192



307-498

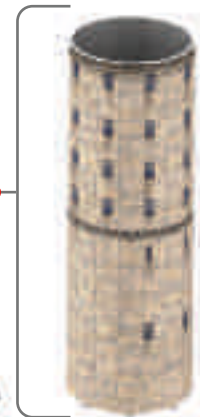

525-540



193-282



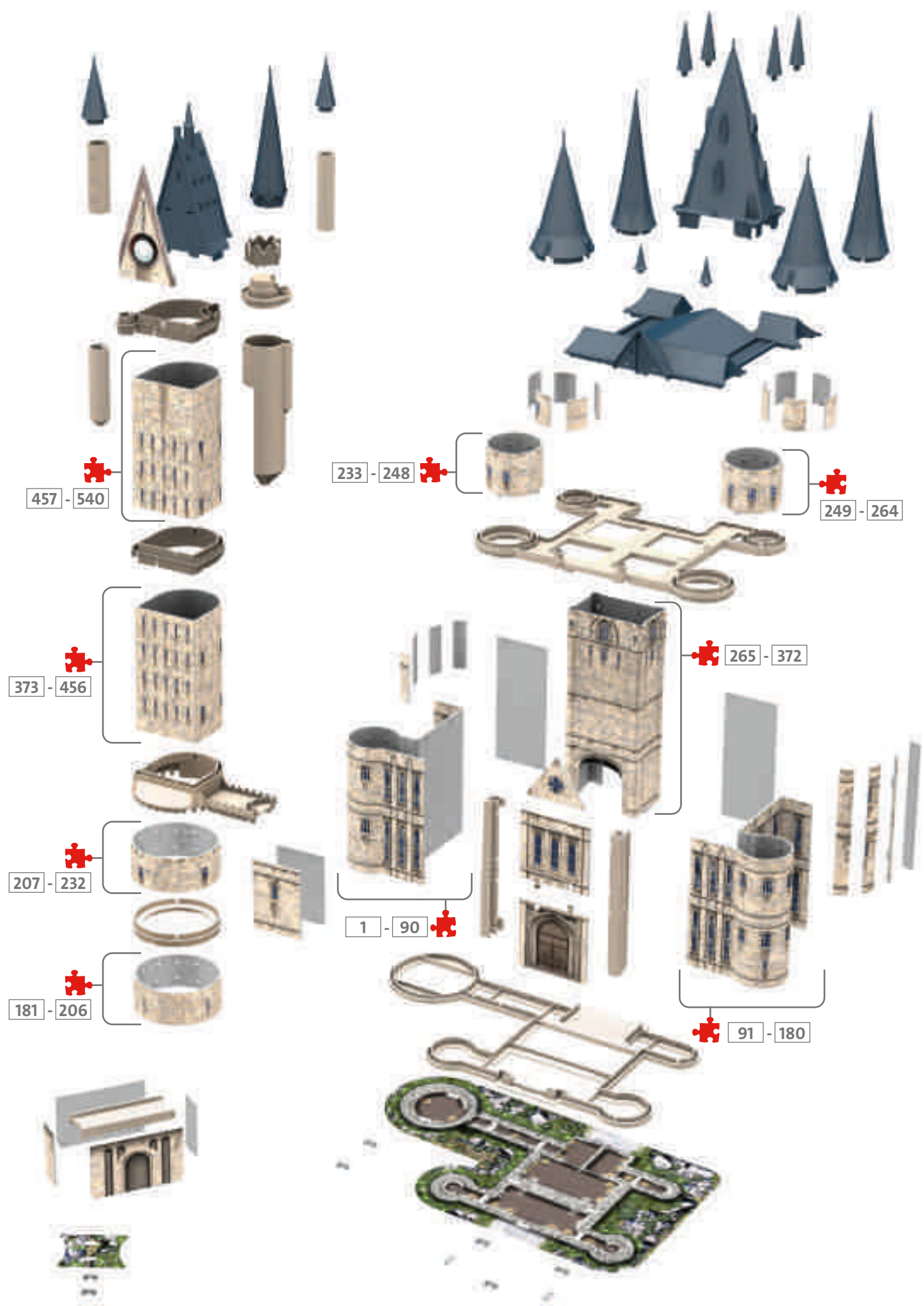

 1-540

 1 - 540

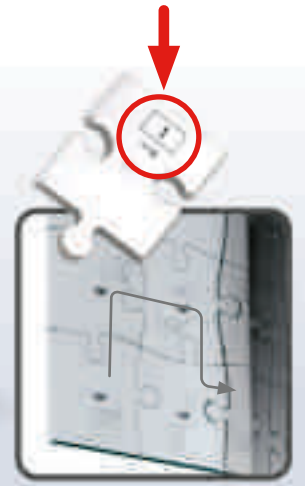

1

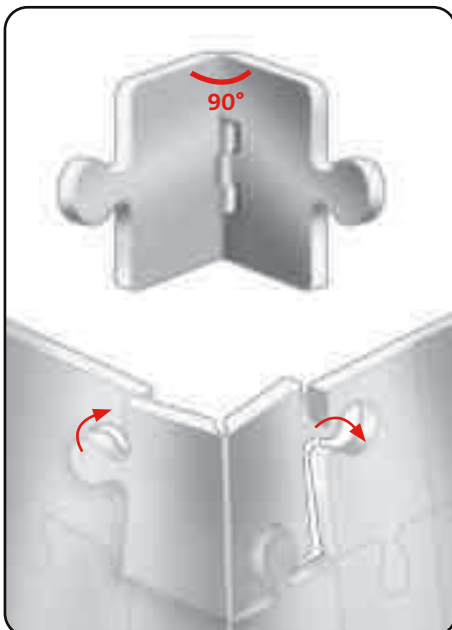
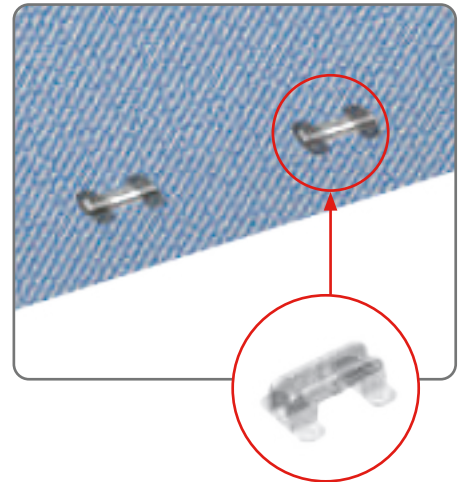
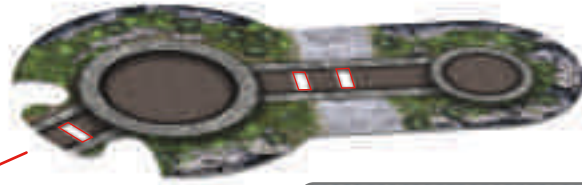
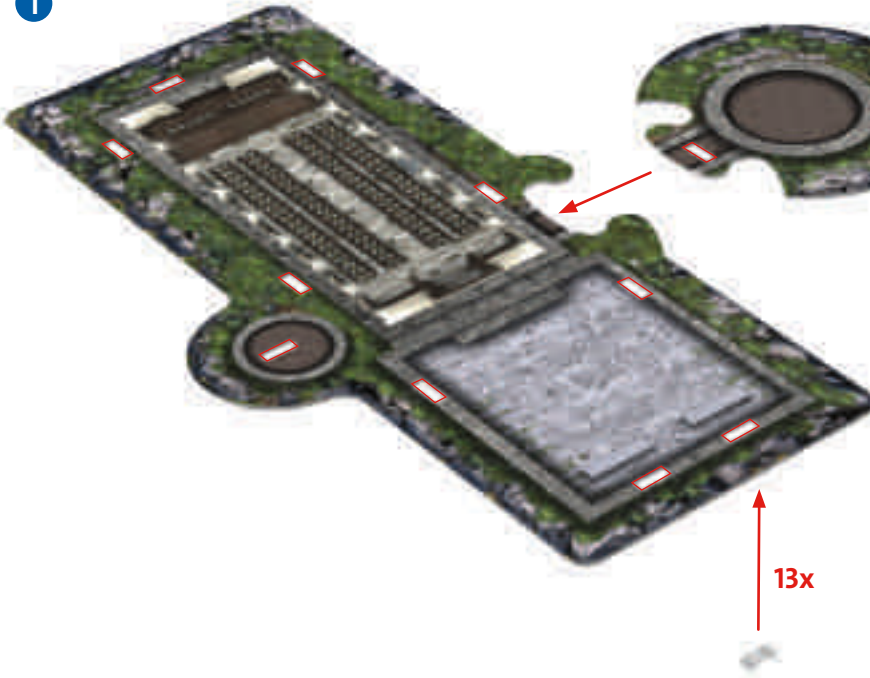

2

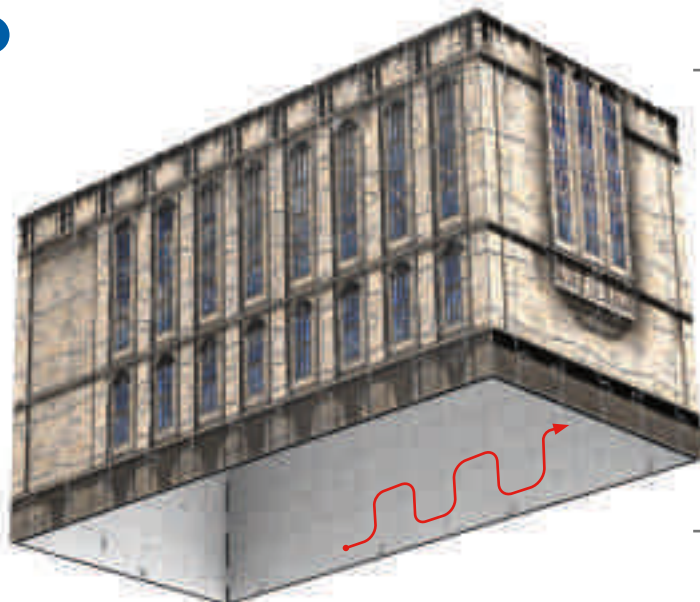

 1-192

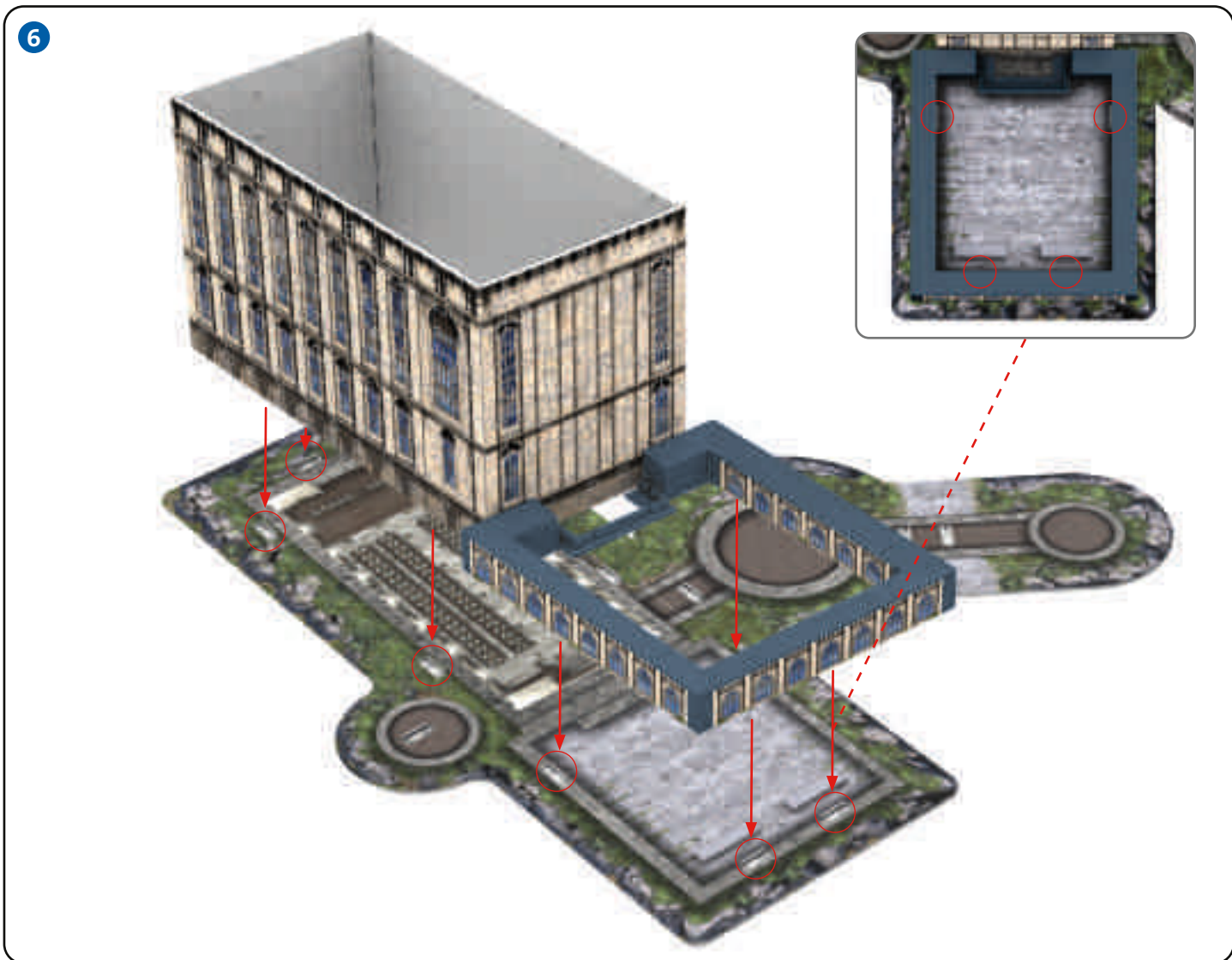
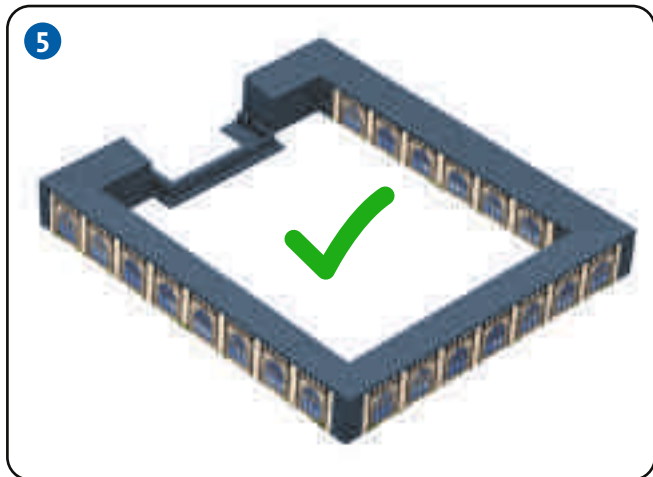
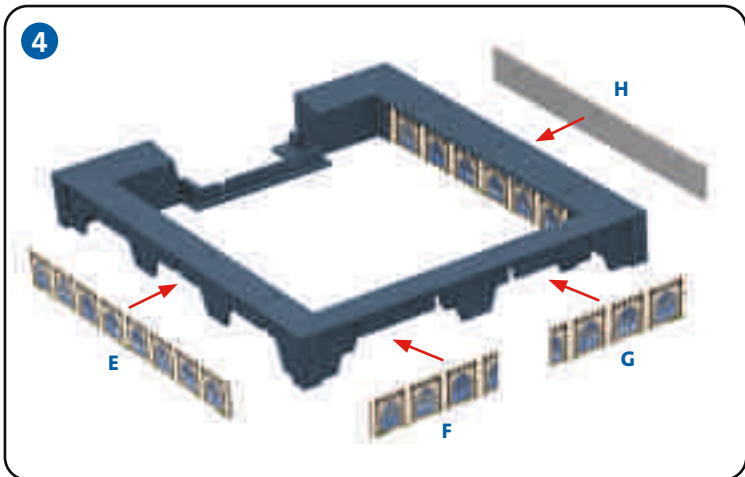
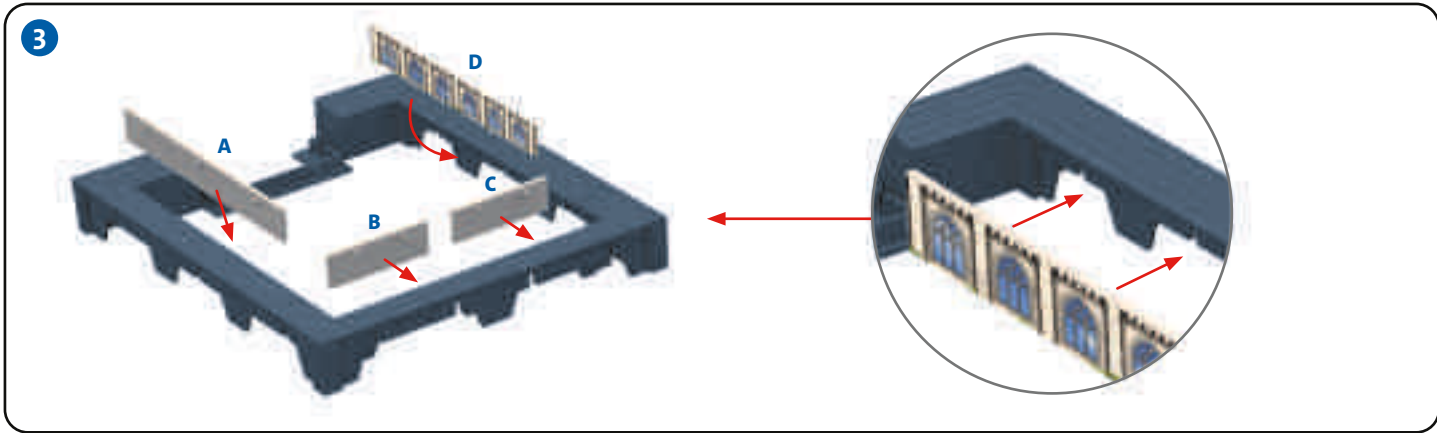

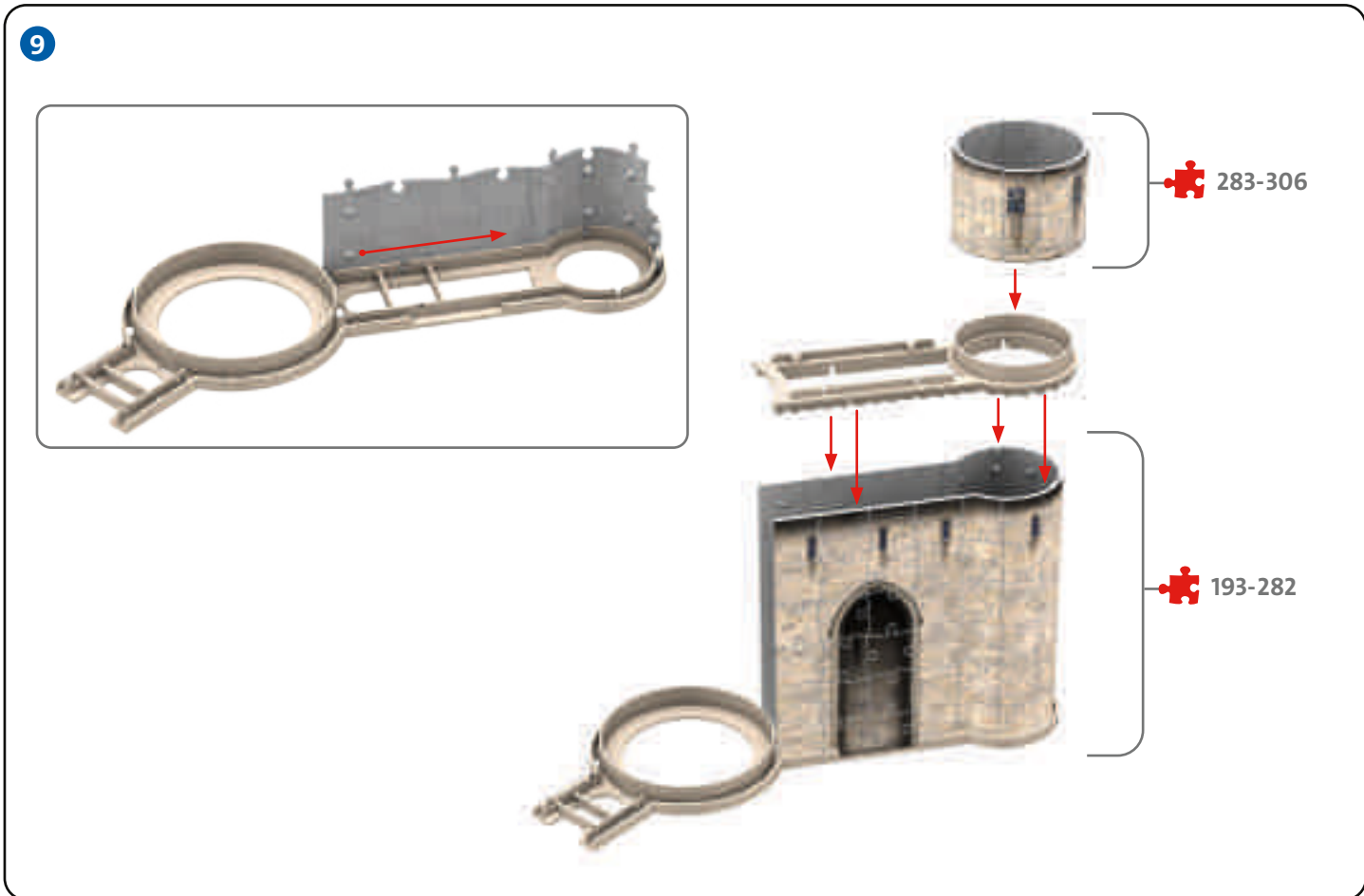
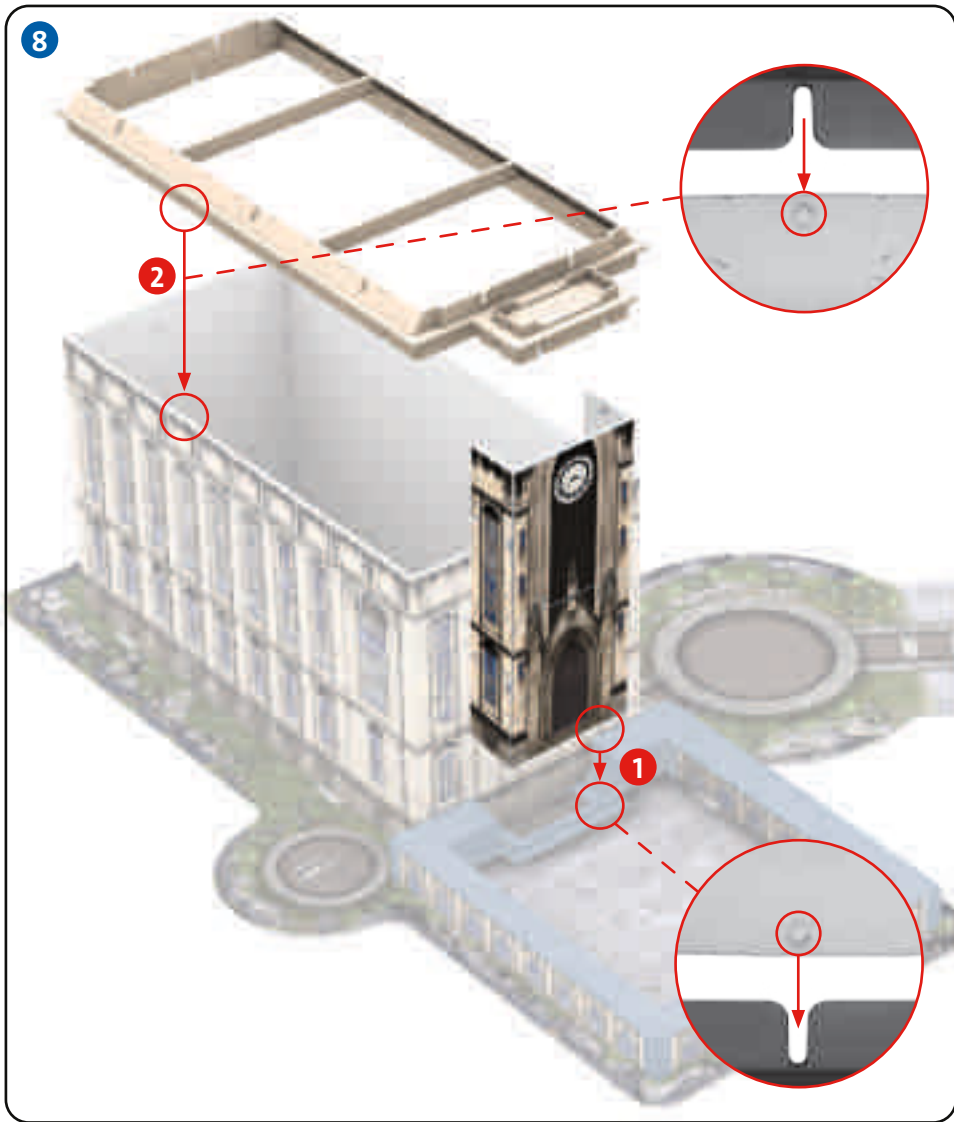
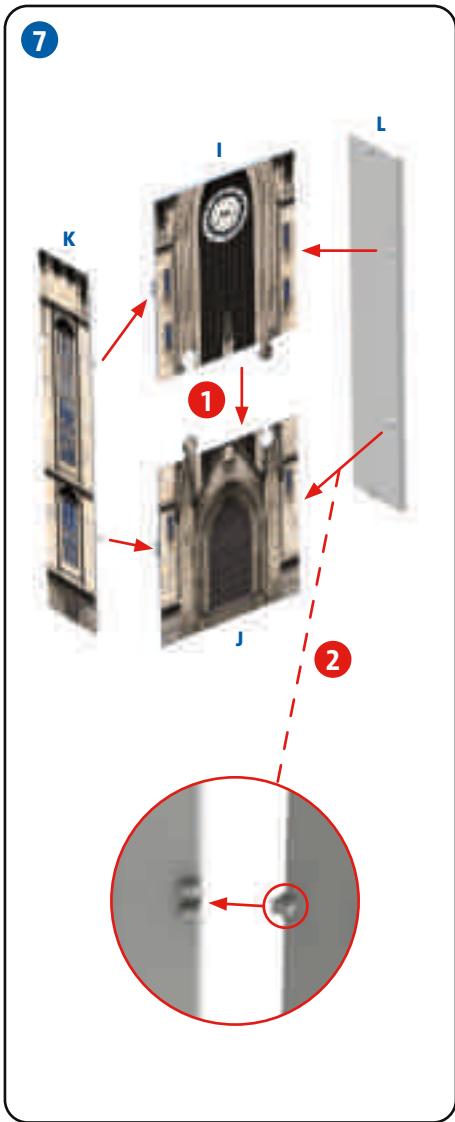

10

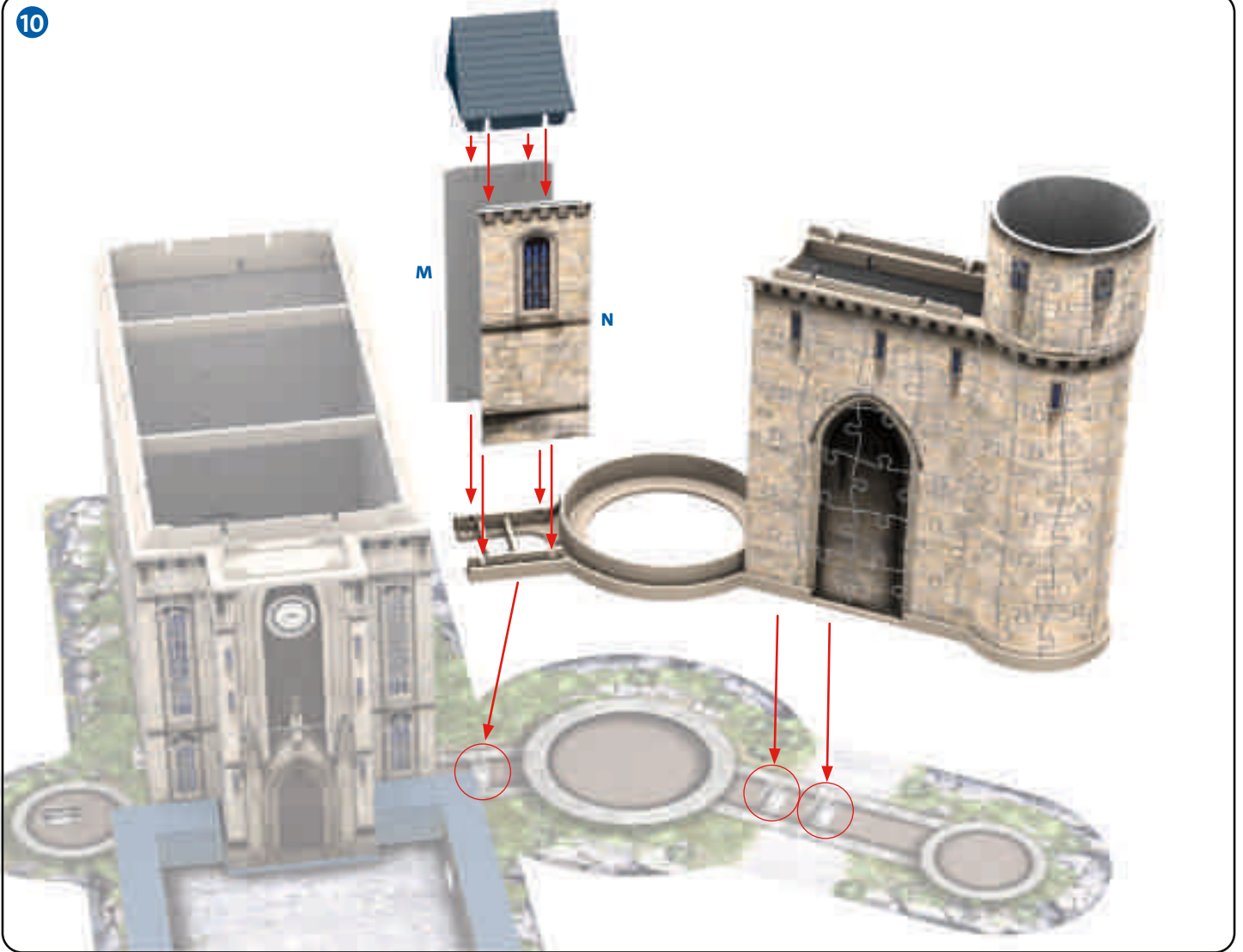

11

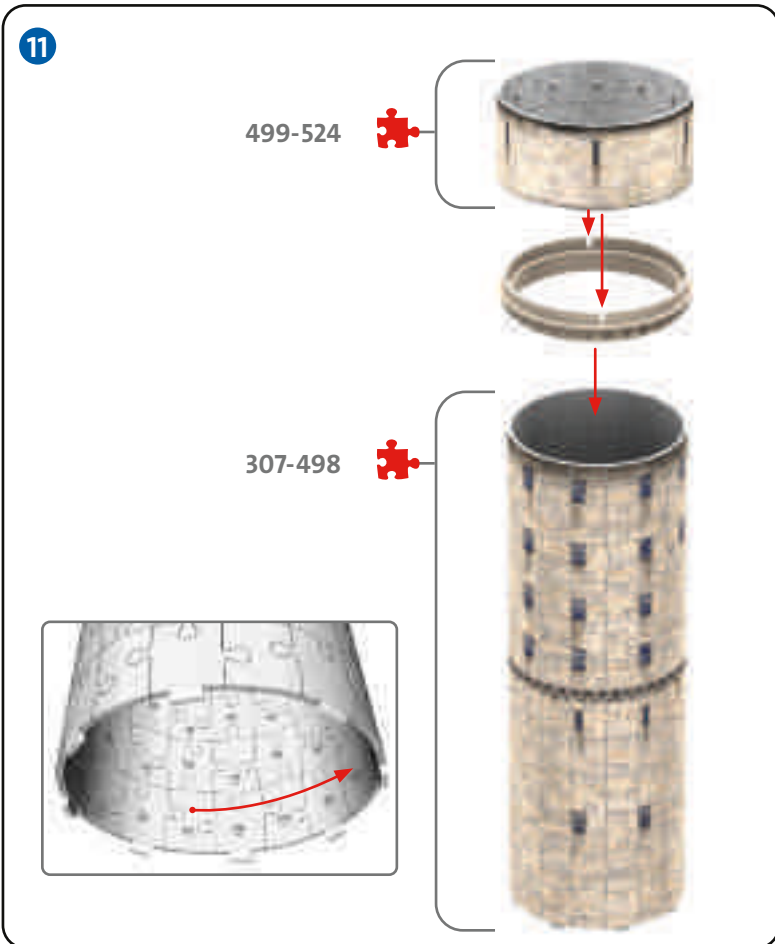

12

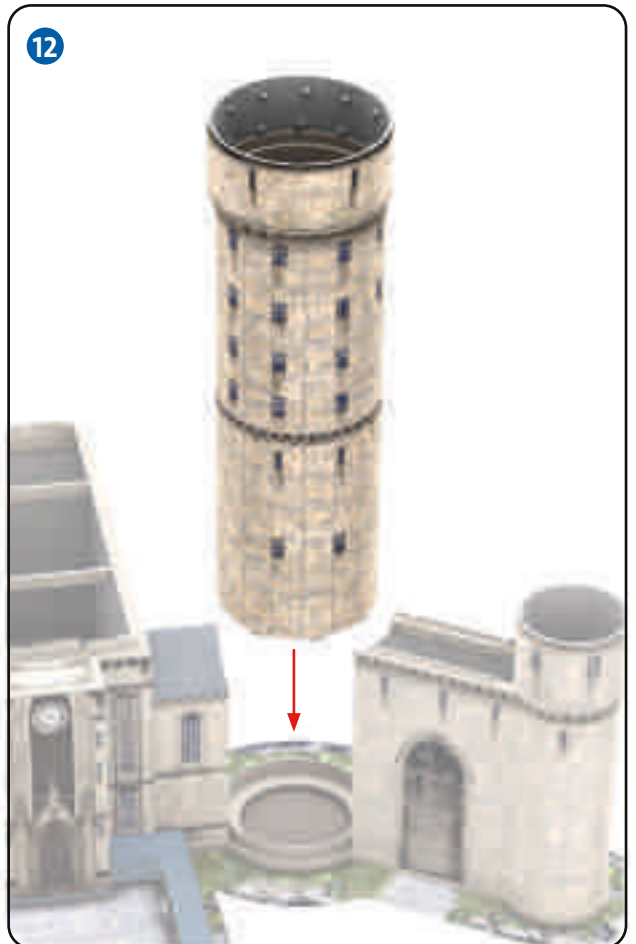

13



525-540



14

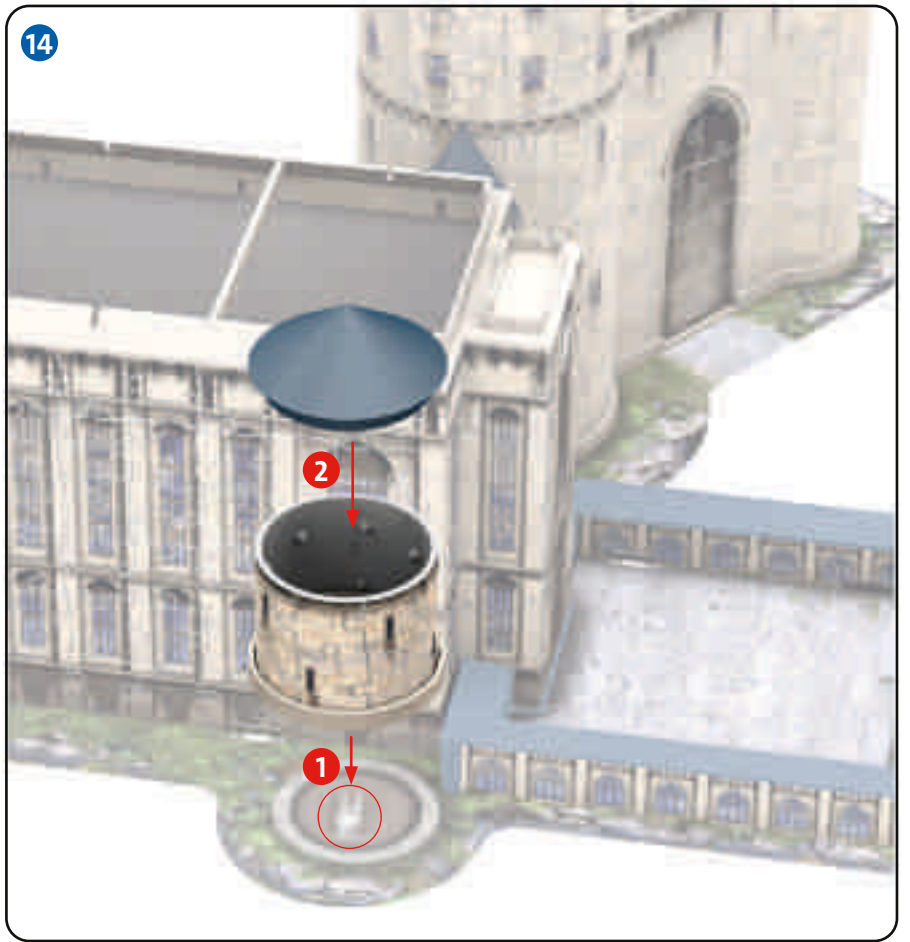

15

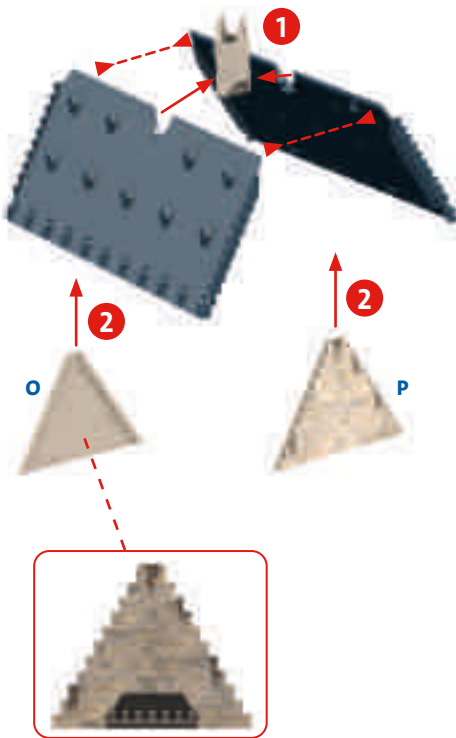

16

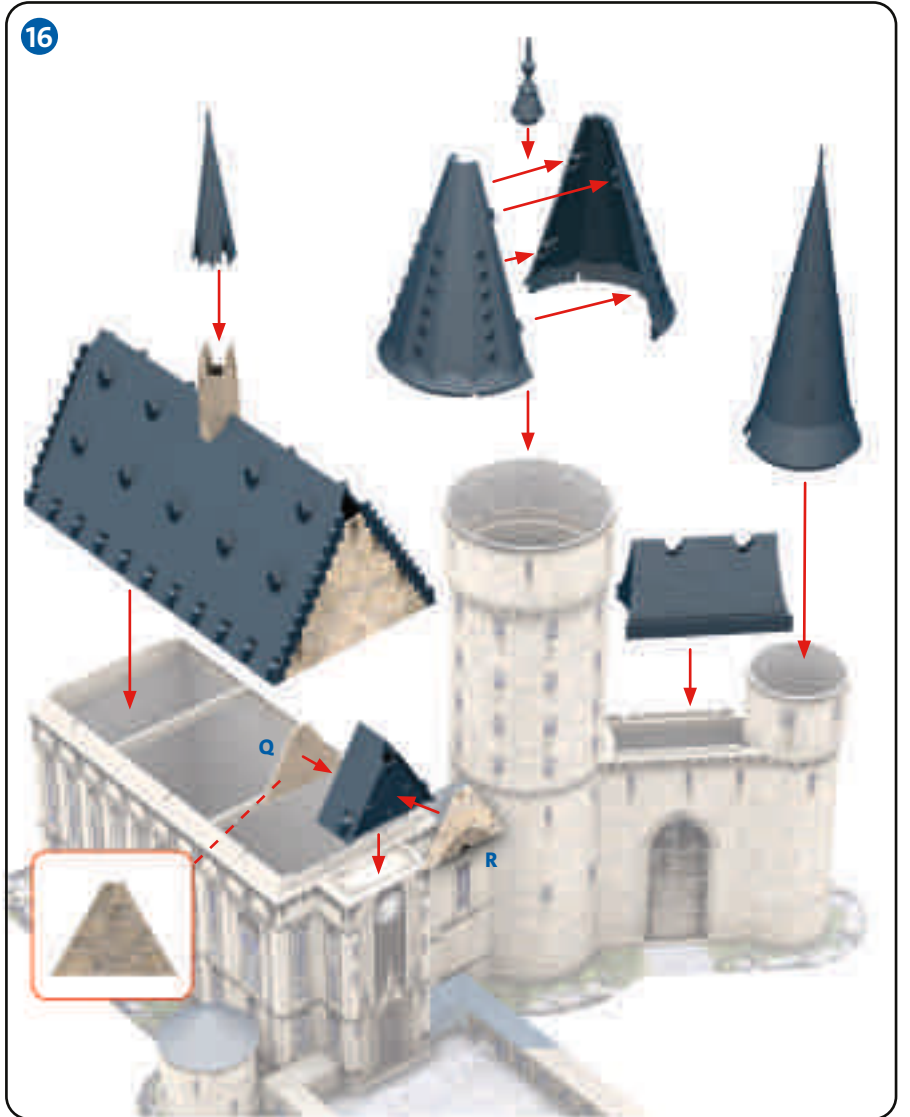

17

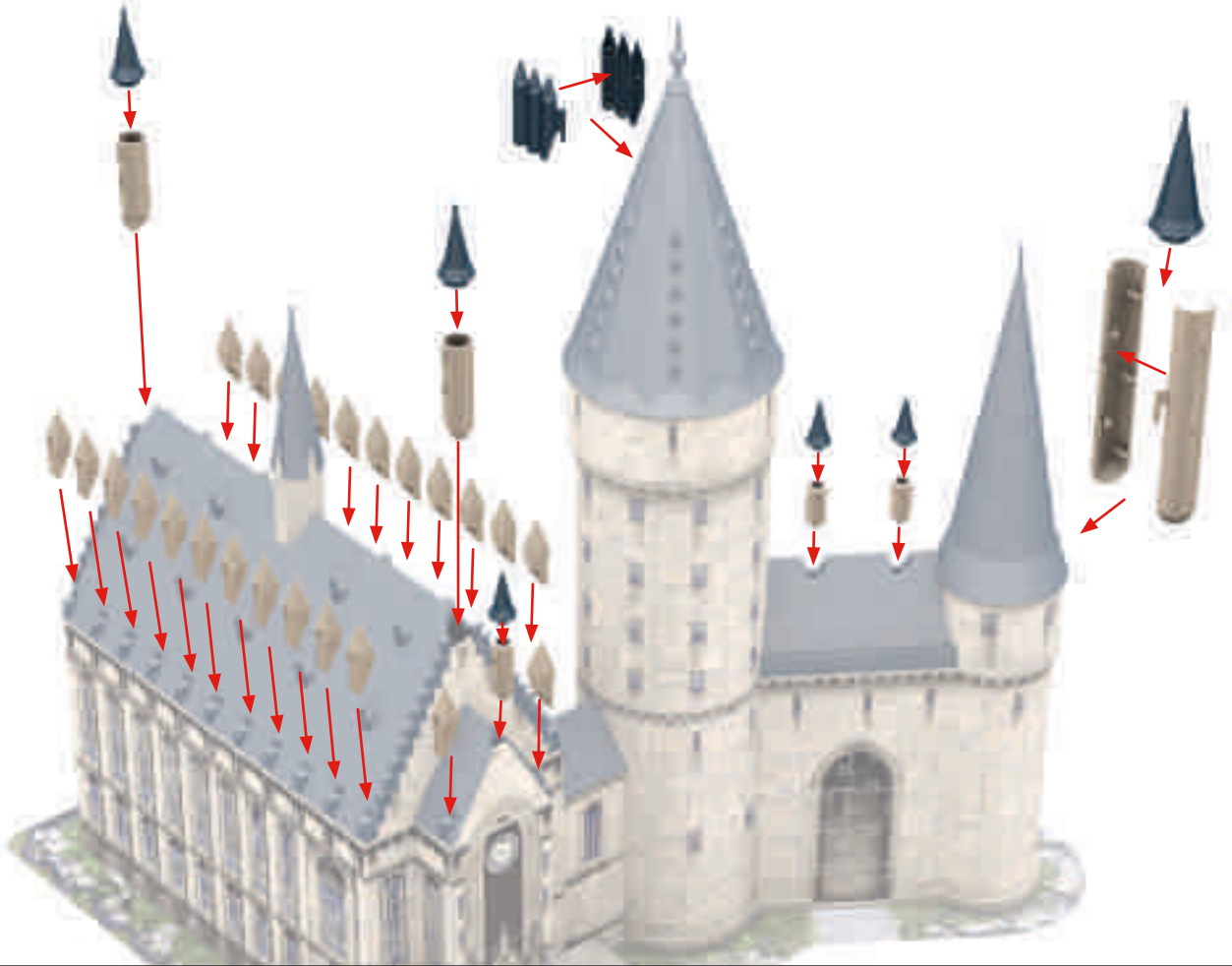

1-540

1 - 540



1

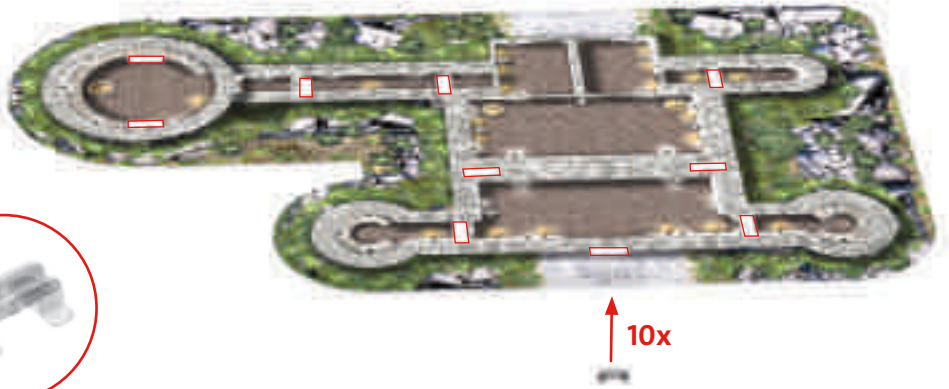
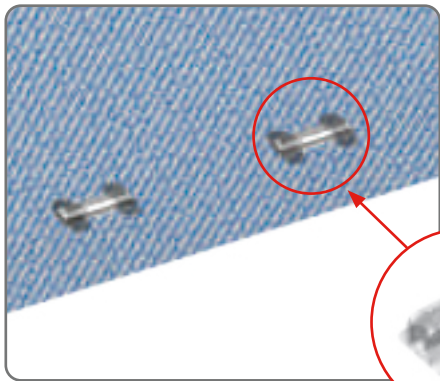

2

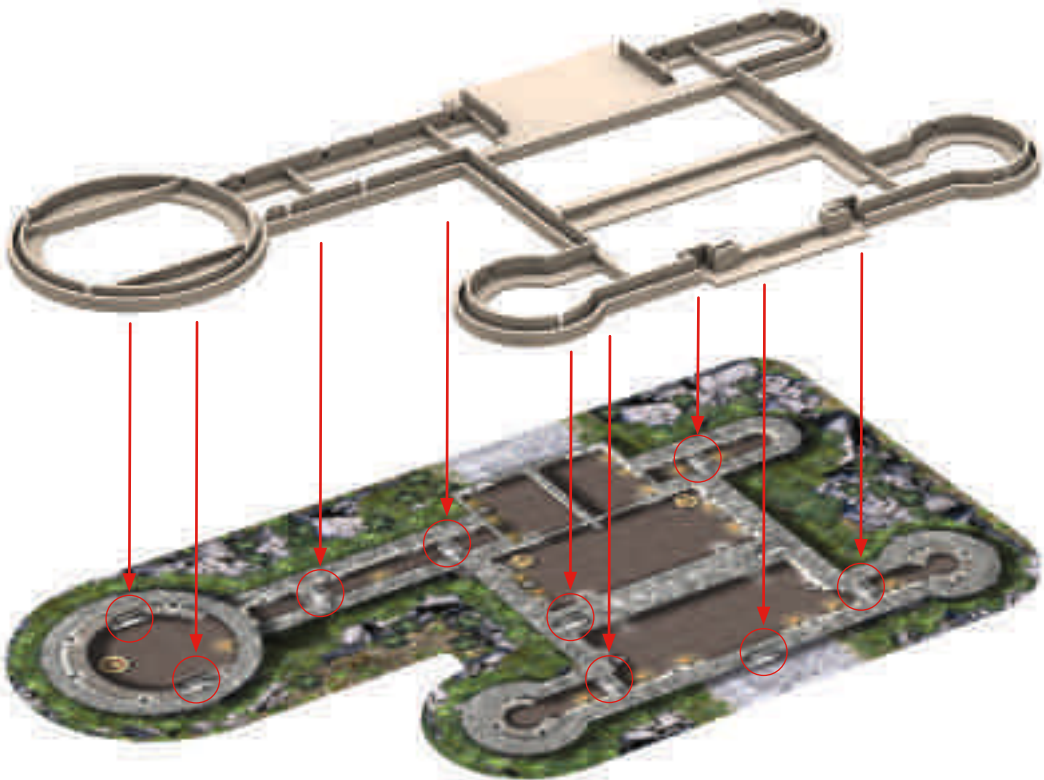

3

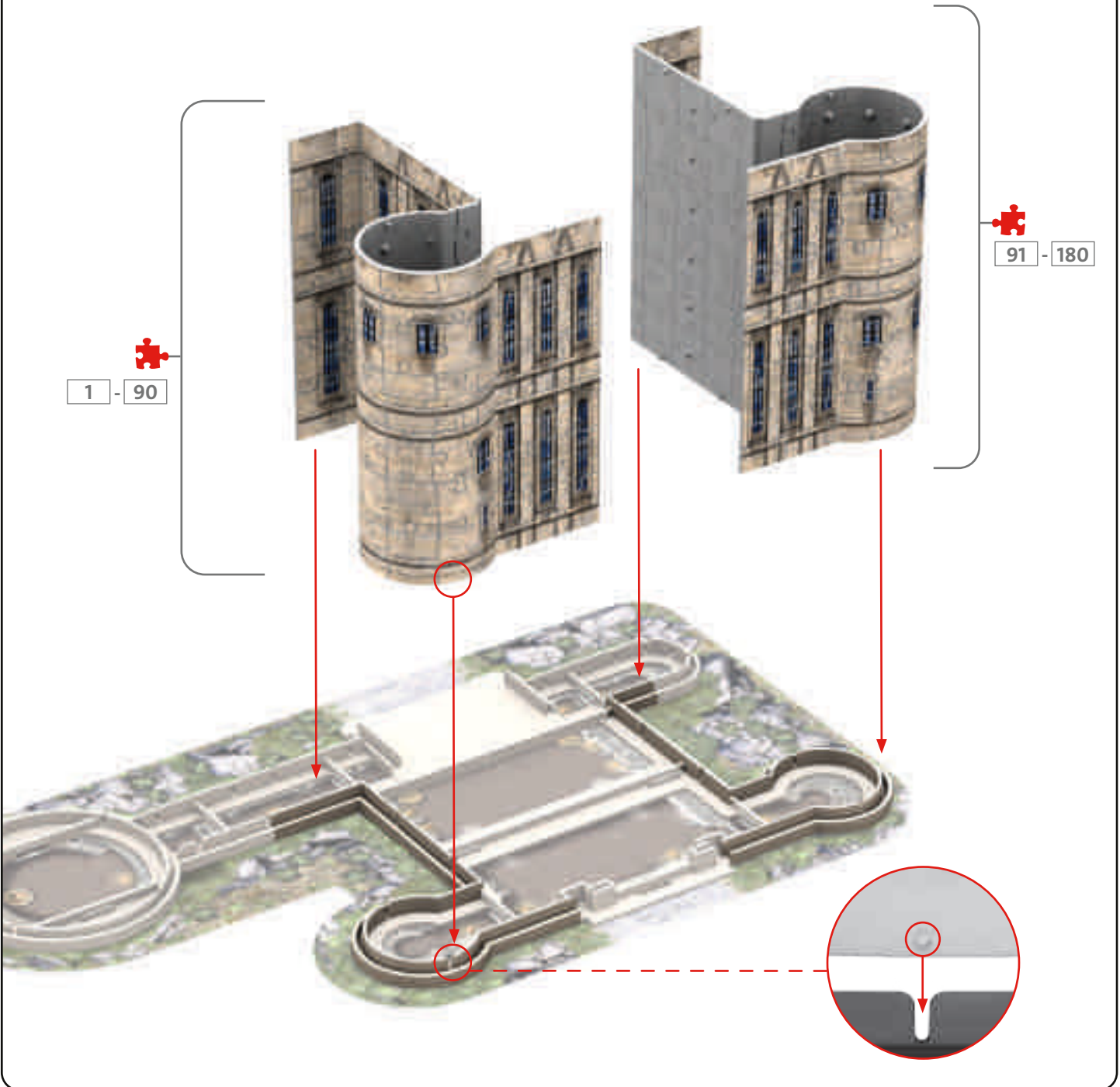
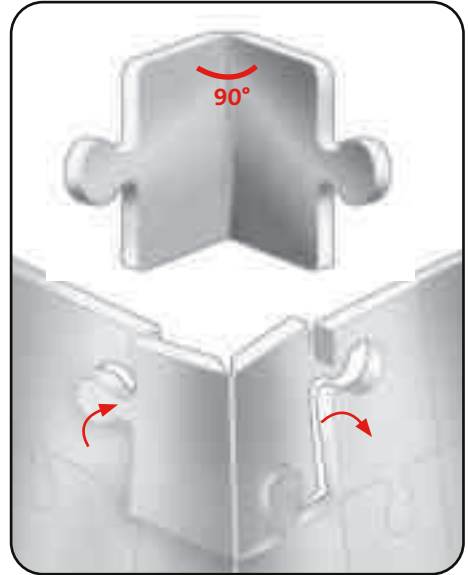
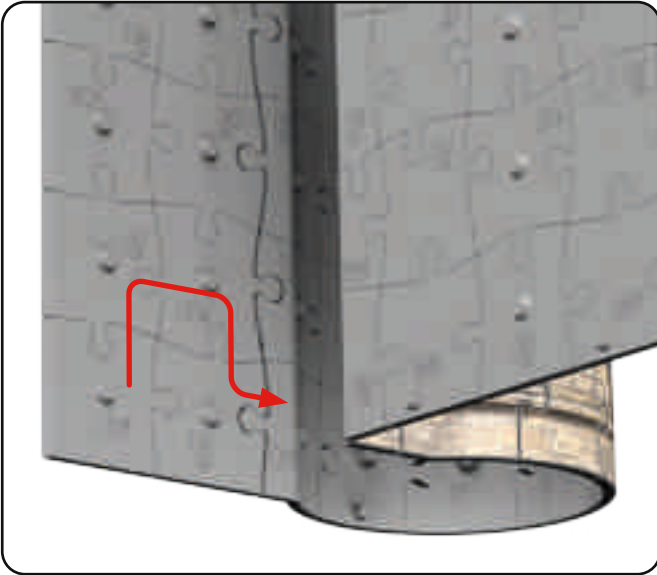

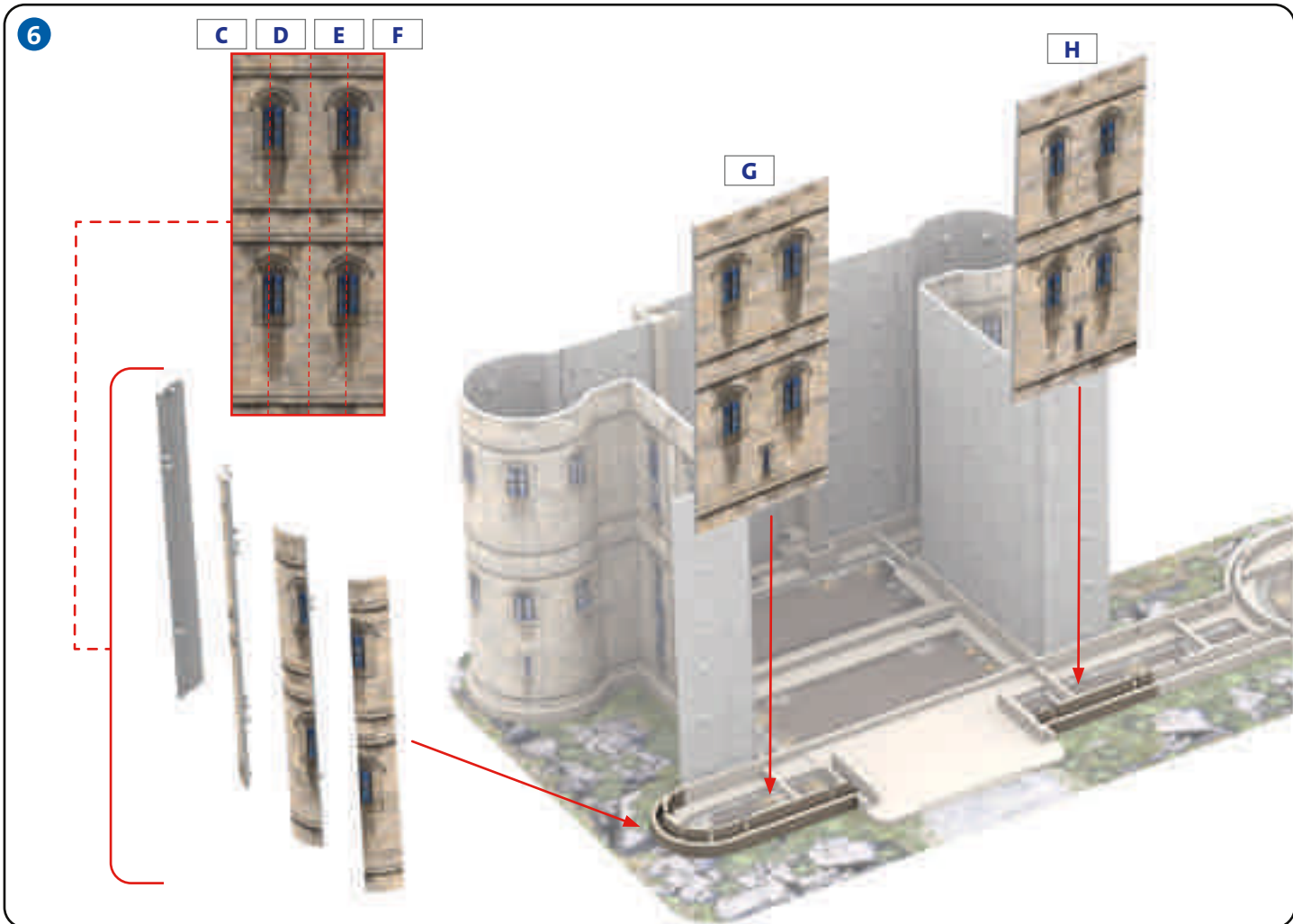
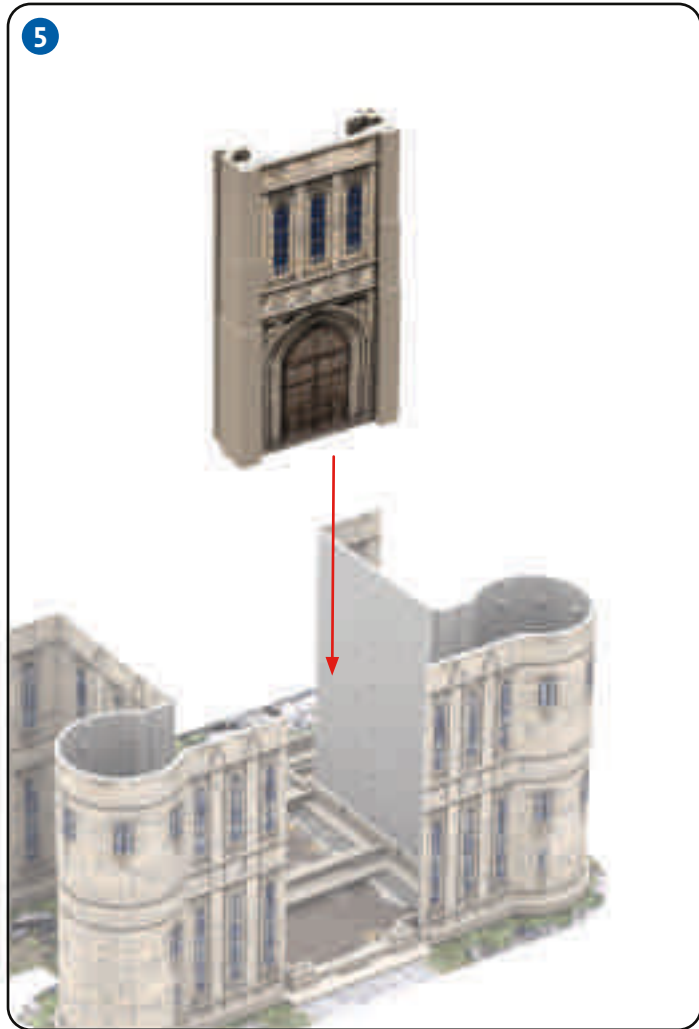
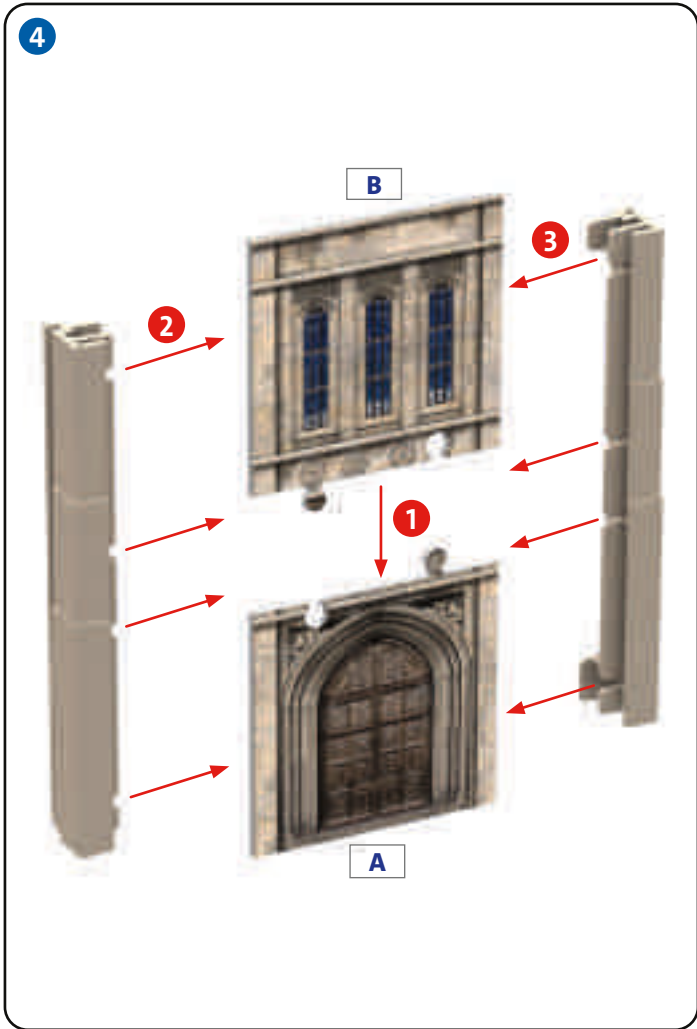

7

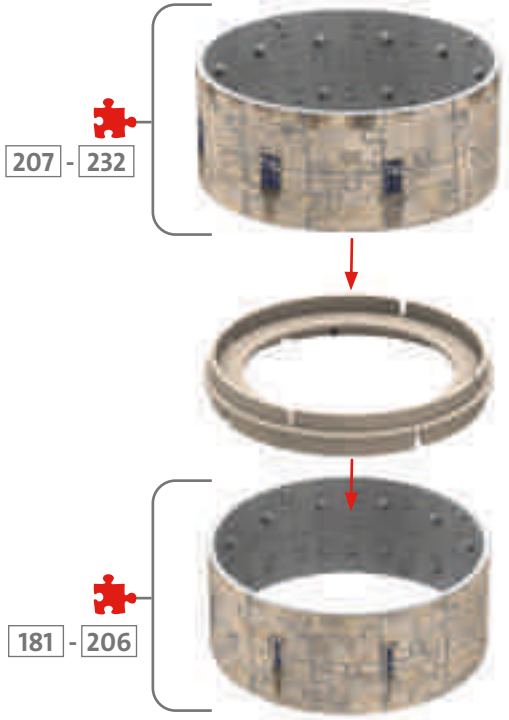

8

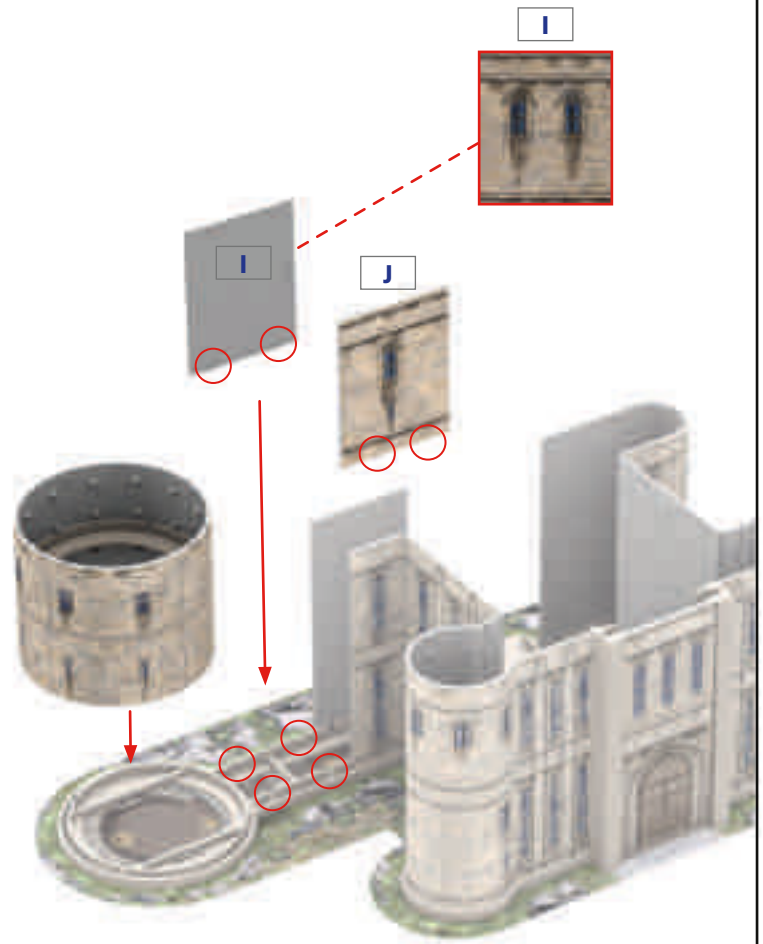

9

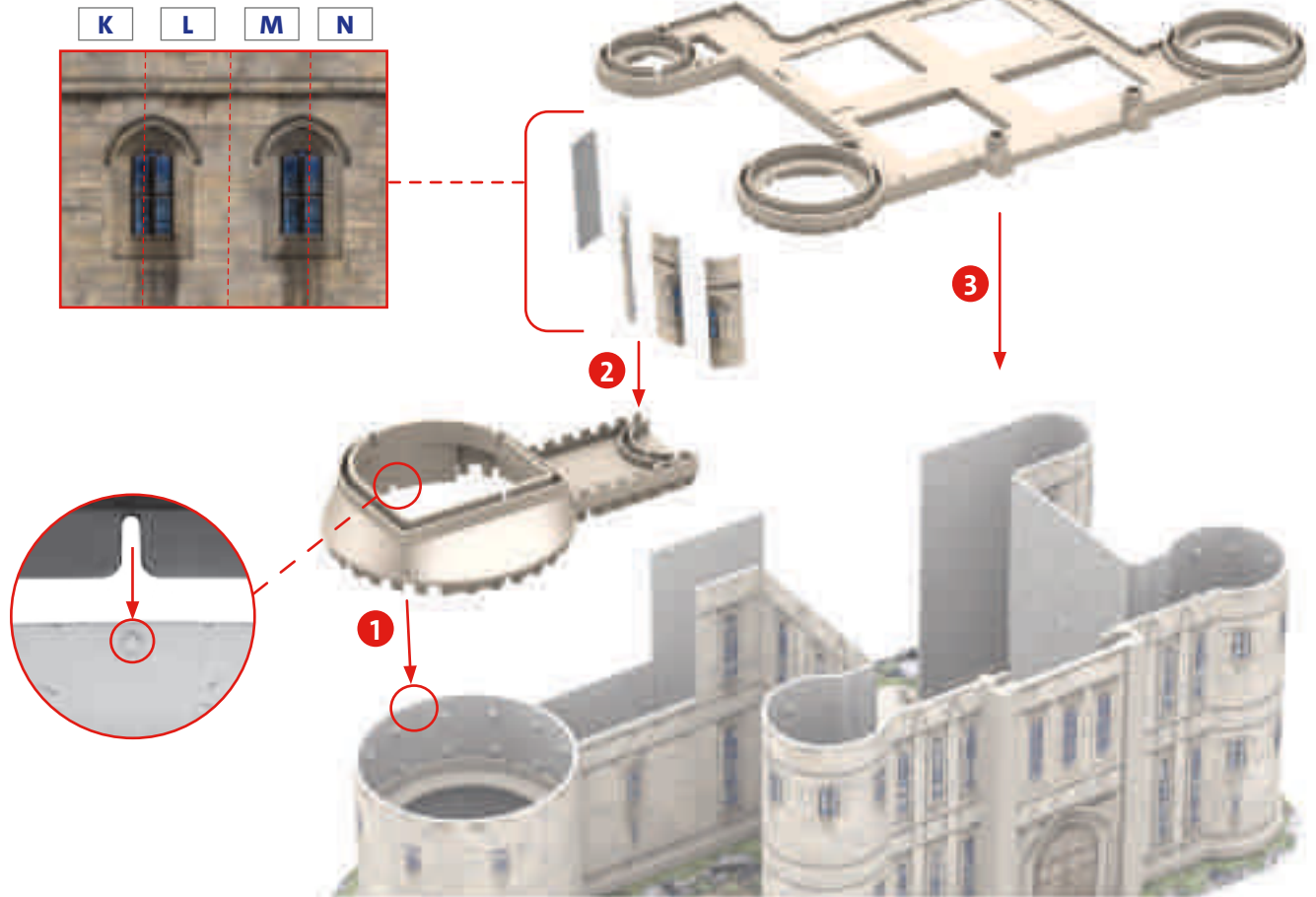

10

233 - 248



249 - 264



11

O P Q R S T U V W X

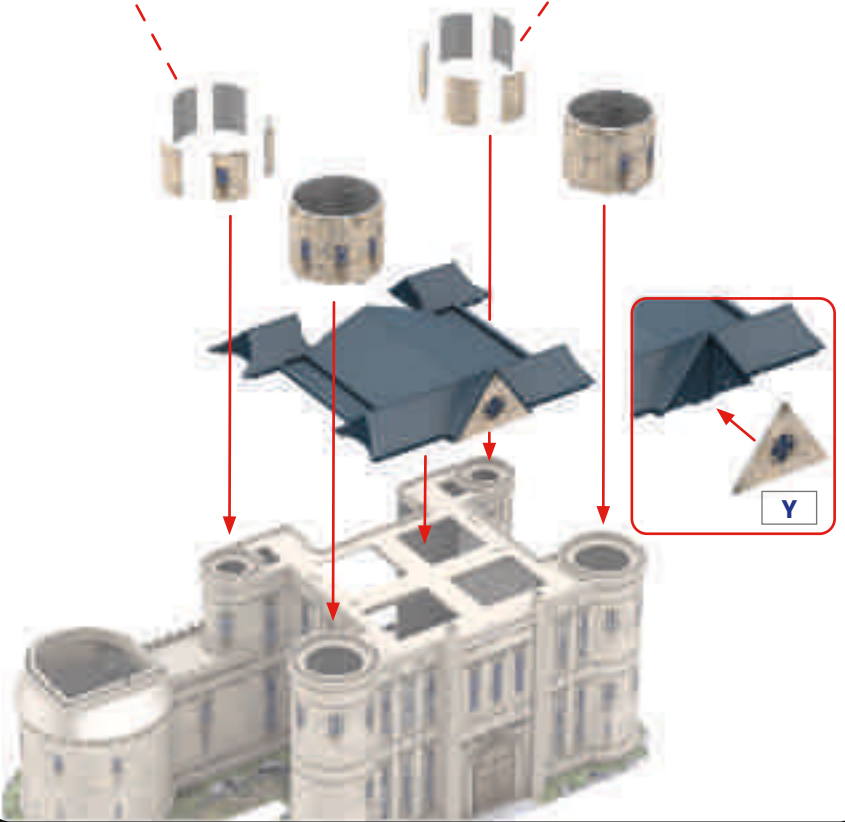

12

265 - 372



13

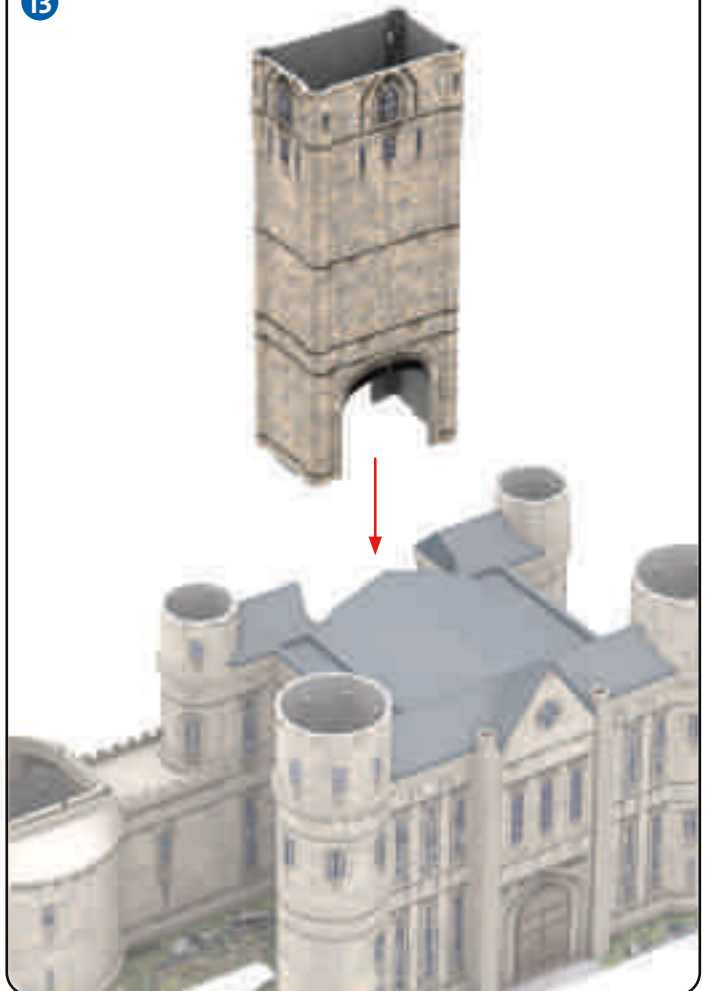

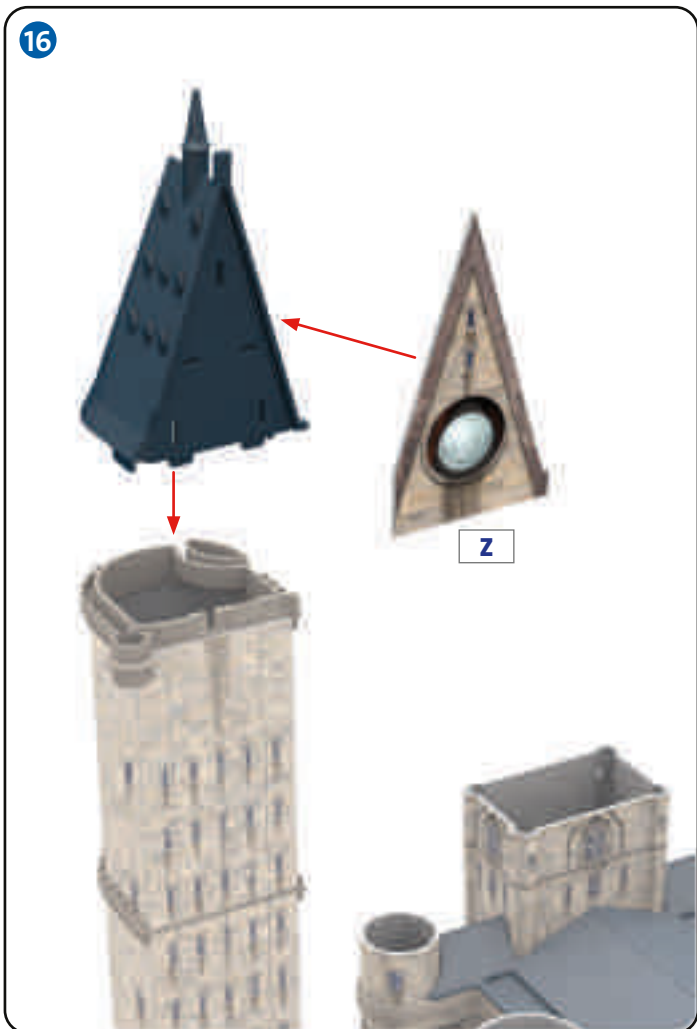
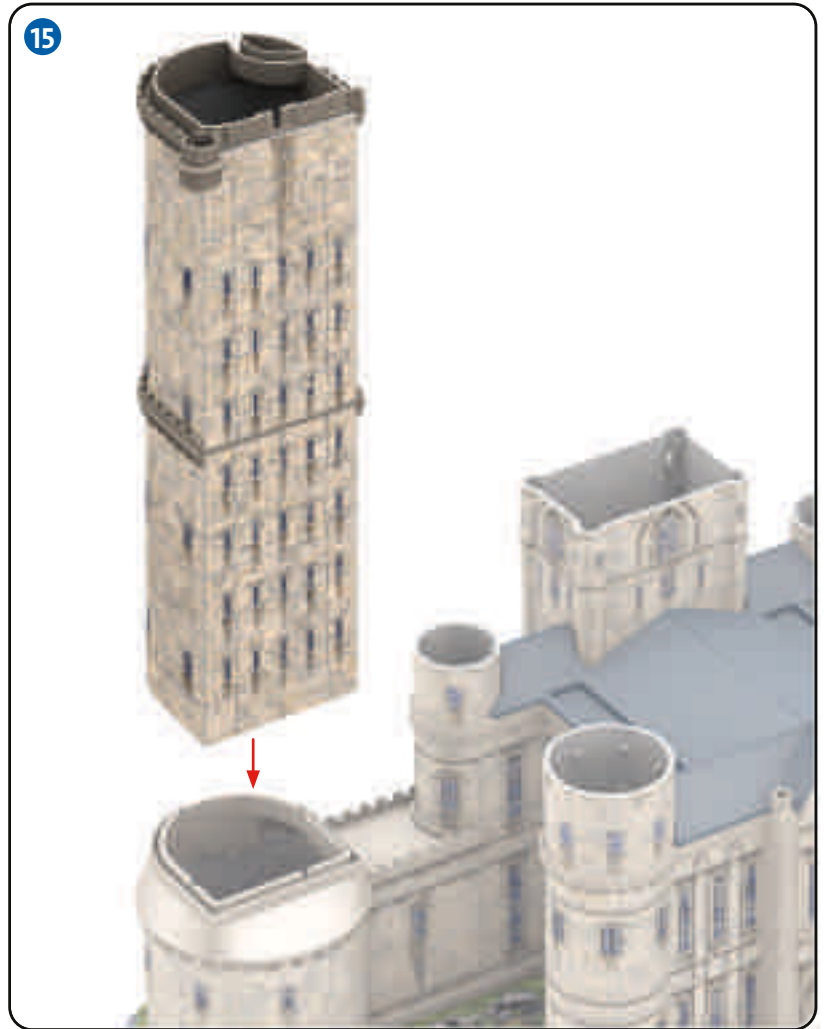
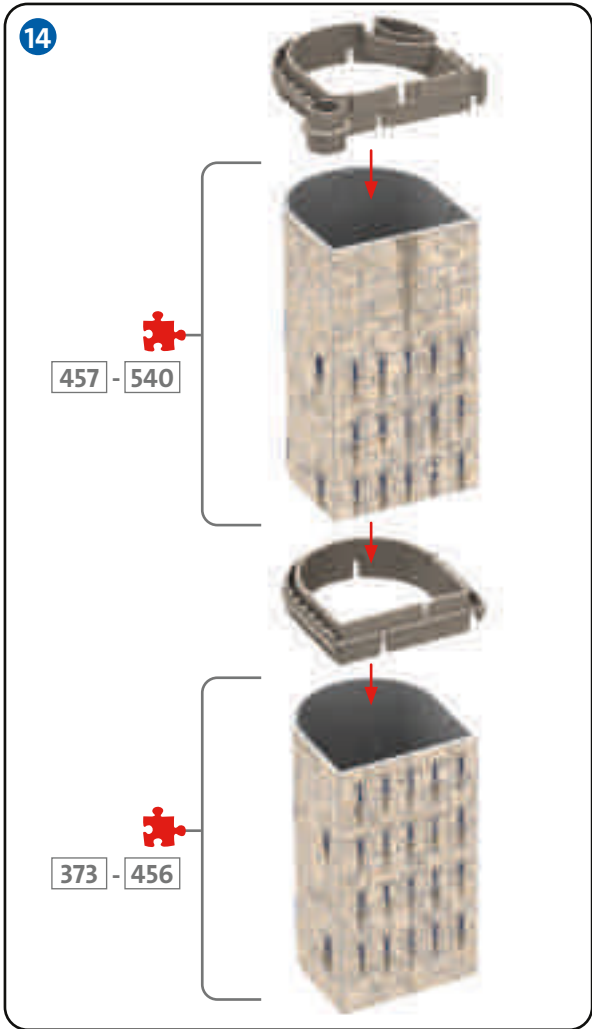

18

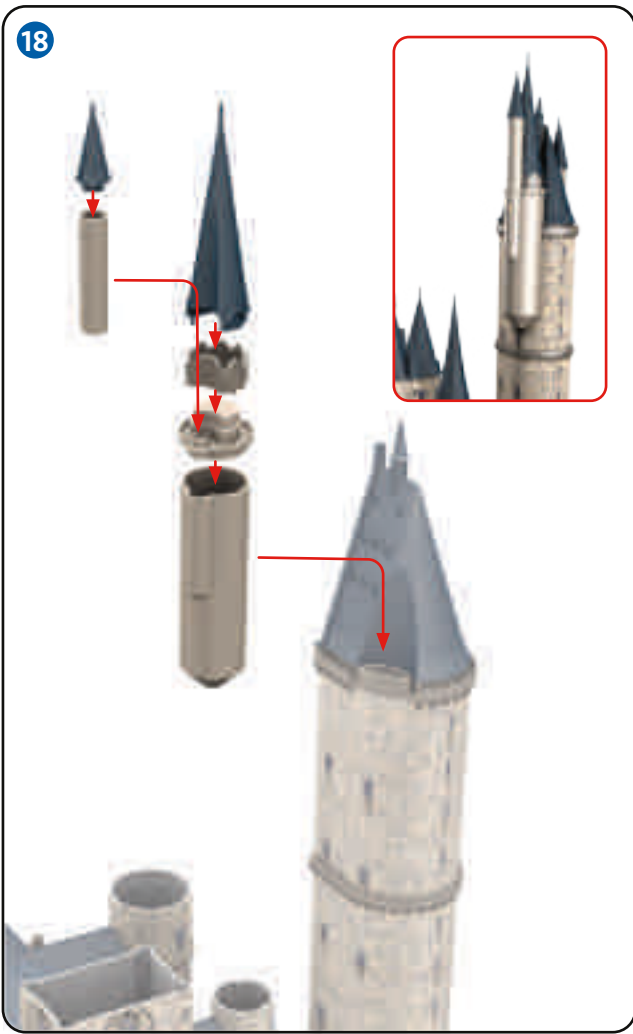

19

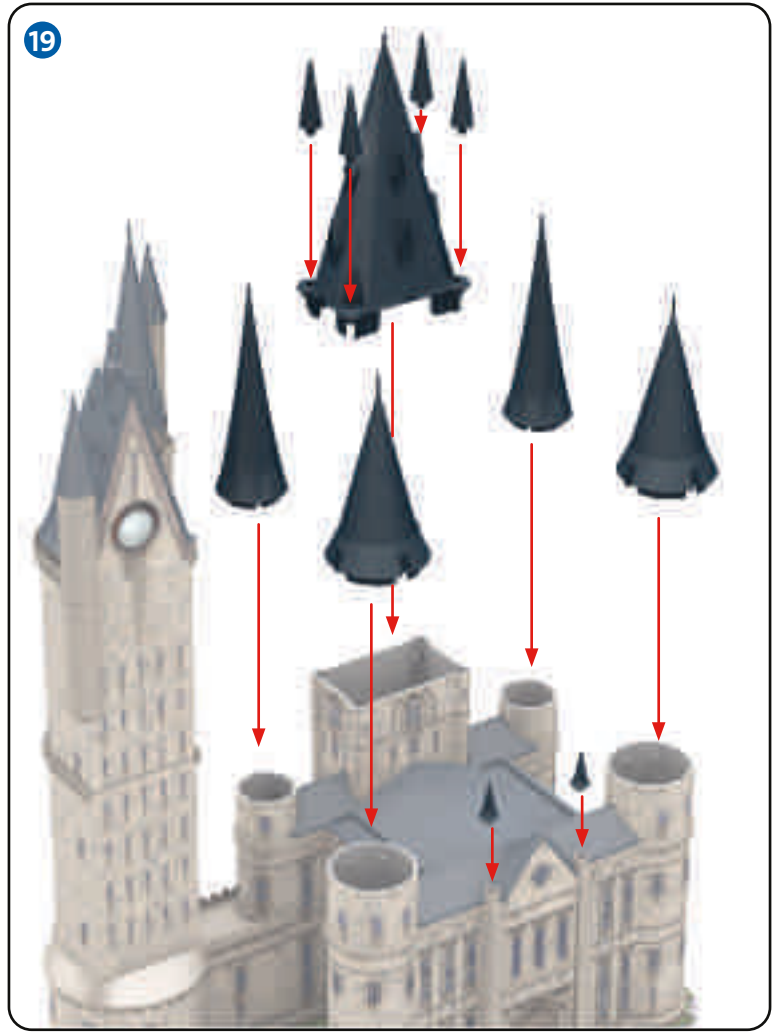

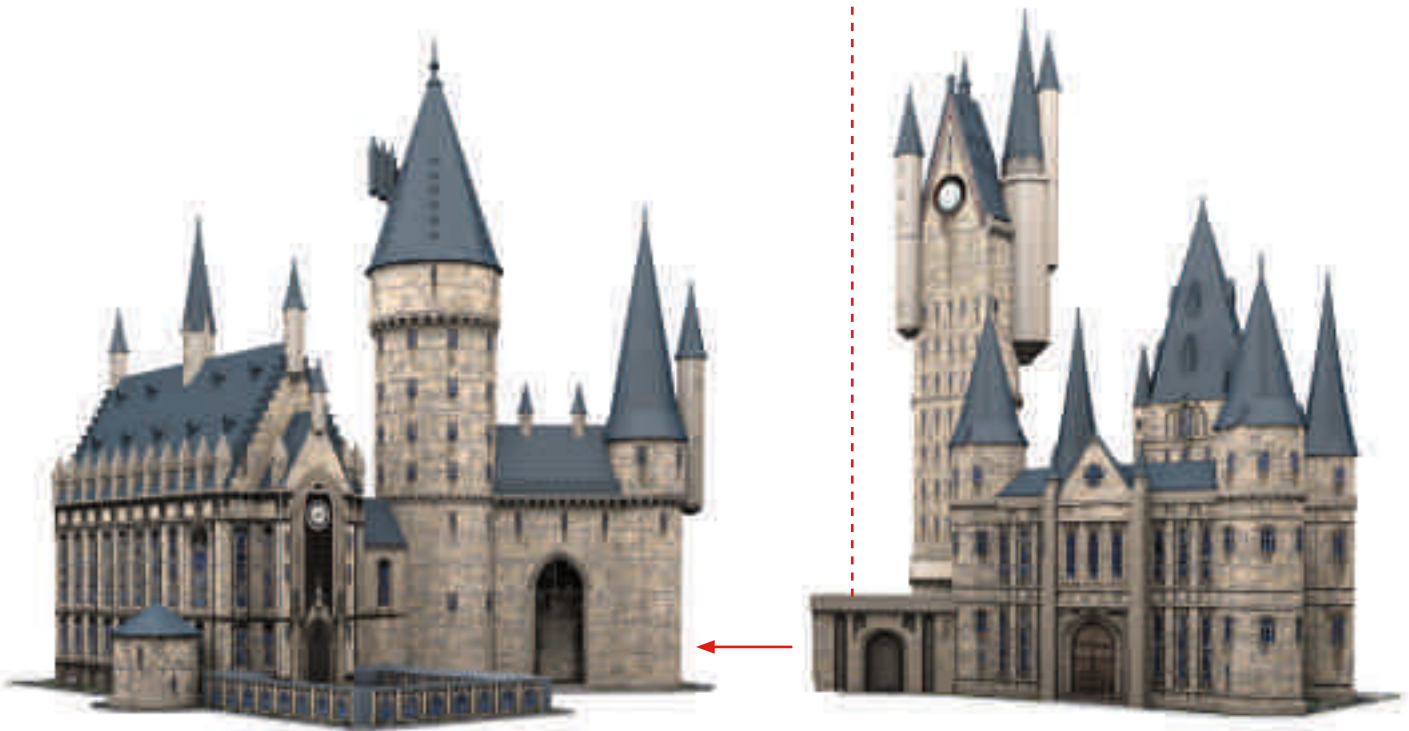
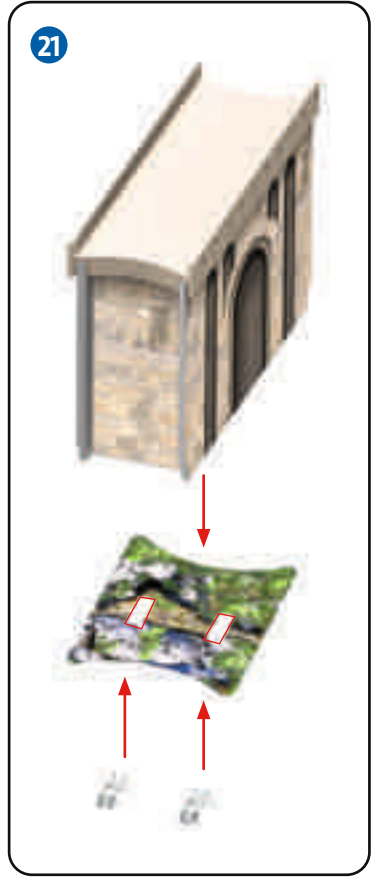
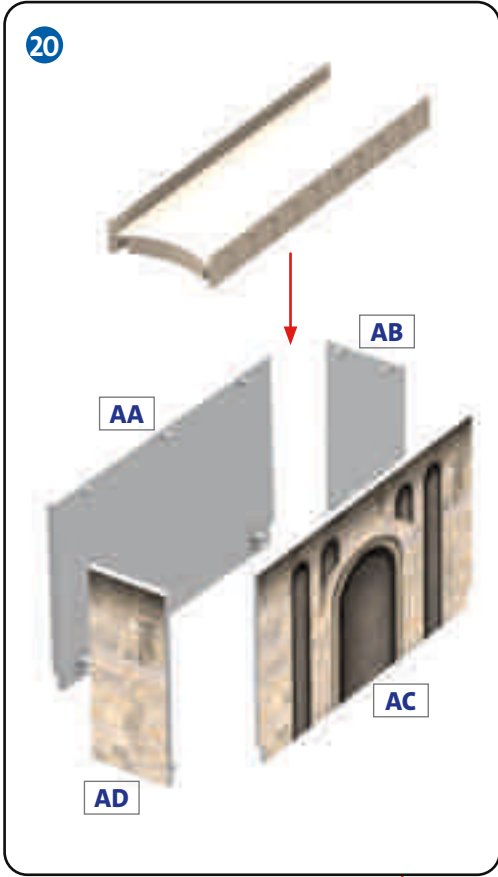

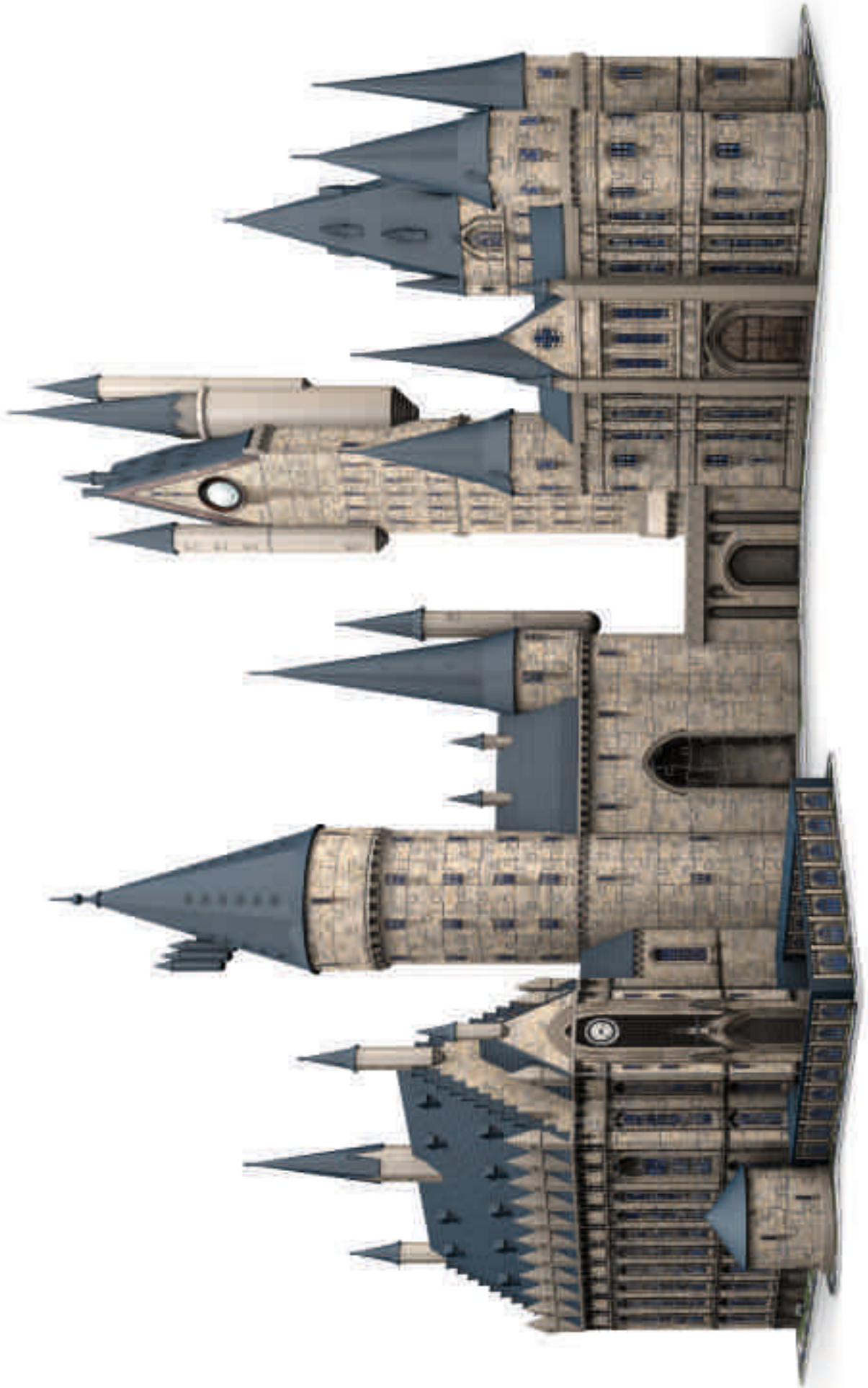

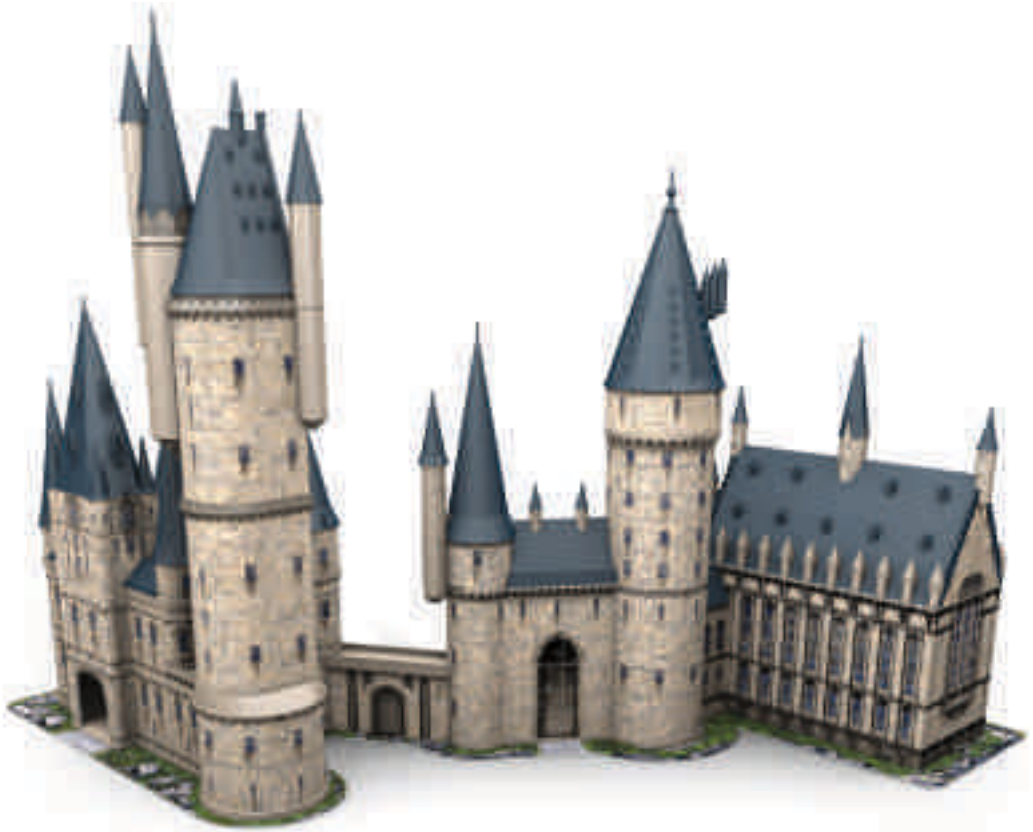



Harry Potter Knight Bus
No. 11 158 9



Pencil Cup Harry Potter
No. 11 154 1



Storage Box Harry Potter
No. 11 258 6